

# 8 ALLOWABLE HOLES

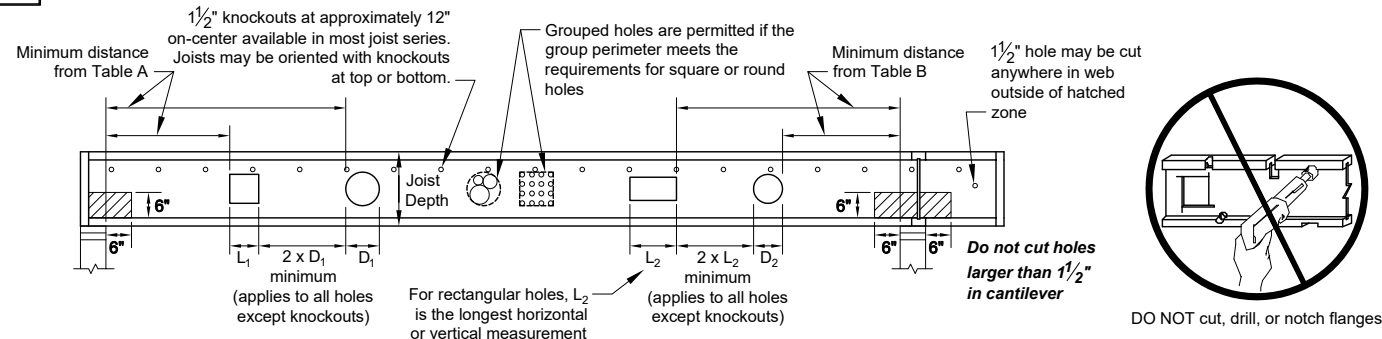

**Table A - End Support**

Minimum distance from edge of hole to inside face of nearest end support

Joist Depth	Joist Series	Round Hole Size									
		2"	4"	6"	8"	10"	12"	14"	16"	18"	20"
		Square or Rectangular Hole Size									
		1.25"	2.5"	4"	5"	6"	7"	8.5"	9.5"	10.5"	13"
9 1/2"	I45L / I45	1'-0"	<b>2'-6"</b>	<b>4'-0"</b>	-	-	-	-	-	-	-
	I58 / I65	1'-6"	<b>3'-0"</b>	<b>5'-0"</b>	-	-	-	-	-	-	-
	I90	2'-0"	3'-6"	<b>5'-6"</b>	-	-	-	-	-	-	-
11 7/8"	I45L / I45	1'-0"	2'-0"	<b>3'-6"</b>	<b>5'-0"</b>	-	-	-	-	-	-
	I58 / I65	1'-6"	3'-0"	<b>4'-6"</b>	<b>6'-6"</b>	-	-	-	-	-	-
	I90 / I90H	1'-6"	3'-6"	5'-6"	<b>7'-0"</b>	-	-	-	-	-	-
	I90HS	2'-0"	4'-0"	6'-6"	-	-	-	-	-	-	-
14"	I45L / I45	1'-0"	2'-0"	3'-0"	<b>4'-0"</b>	<b>6'-0"</b>	-	-	-	-	-
	I58 / I65	1'-0"	2'-6"	4'-0"	<b>5'-6"</b>	<b>8'-0"</b>	-	-	-	-	-
	I90 / I90H	1'-0"	3'-0"	5'-0"	6'-6"	<b>9'-0"</b>	-	-	-	-	-
	I90HS	2'-0"	4'-0"	6'-0"	8'-0"	-	-	-	-	-	-
16"	I45 / I65	1'-0"	1'-6"	3'-0"	4'-0"	<b>5'-0"</b>	<b>8'-0"</b>	-	-	-	-
	I58	1'-0"	1'-6"	3'-0"	4'-6"	<b>6'-6"</b>	<b>9'-6"</b>	-	-	-	-
	I90 / I90H	1'-0"	2'-0"	4'-0"	6'-0"	8'-6"	<b>10'-6"</b>	-	-	-	-
	I90HS	2'-0"	4'-0"	6'-0"	8'-0"	10'-0"	-	-	-	-	-
18"	I45 / I65	1'-0"	1'-0"	2'-6"	3'-6"	4'-6"	<b>6'-0"</b>	<b>9'-0"</b>	-	-	-
	I90 / I90H	1'-0"	1'-0"	2'-6"	5'-0"	7'-0"	9'-6"	<b>12'-6"</b>	-	-	-
	I90HS	2'-0"	4'-0"	6'-0"	8'-0"	10'-0"	12'-0"	-	-	-	-
20"	I45 / I65	1'-0"	1'-0"	2'-0"	3'-0"	4'-0"	5'-0"	<b>7'-0"</b>	<b>10'-6"</b>	-	-
	I90 / I90H	1'-0"	1'-0"	2'-0"	4'-0"	6'-0"	8'-0"	11'-0"	<b>14'-0"</b>	-	-
	I90HS	2'-0"	4'-0"	6'-0"	8'-0"	9'-6"	11'-6"	14'-0"	-	-	-
22"	I65	1'-0"	1'-0"	1'-6"	2'-6"	3'-6"	4'-6"	5'-6"	7'-6"	<b>11'-6"</b>	-
	I90 / I90H	1'-0"	1'-0"	1'-0"	3'-0"	5'-0"	7'-0"	9'-0"	12'-6"	<b>16'-0"</b>	-
	I90HS	2'-0"	4'-0"	6'-0"	8'-0"	9'-6"	11'-6"	13'-6"	16'-0"	-	-
24" to 26"	I65	1'-0"	1'-6"	2'-6"	3'-6"	4'-0"	5'-0"	6'-0"	7'-6"	<b>10'-0"</b>	-
	I90 / I90H	1'-0"	1'-0"	2'-0"	3'-6"	5'-0"	6'-6"	8'-6"	10'-6"	14'-6"	<b>18'-6"</b>
	I90HS	2'-0"	4'-0"	6'-0"	7'-6"	9'-6"	11'-6"	13'-6"	15'-0"	18'-0"	-
28" to 32"	I65	1'-0"	2'-0"	2'-6"	3'-6"	4'-0"	5'-0"	6'-0"	7'-0"	8'-0"	10'-6"
	I90 / I90H	1'-0"	1'-6"	2'-6"	4'-0"	5'-6"	6'-6"	8'-0"	9'-6"	11'-6"	14'-6"
	I90HS	2'-0"	3'-6"	5'-0"	7'-0"	8'-6"	10'-0"	12'-0"	13'-6"	16'-0"	18'-6"

**Table B - Intermediate or Cantilever Support**

Minimum distance from edge of hole to inside face of nearest intermediate or cantilever support

Joist Depth	Joist Series	Round Hole Size									
		2"	4"	6"	8"	10"	12"	14"	16"	18"	20"
		Square or Rectangular Hole Size									
		1.25"	2.5"	4"	5"	6"	7"	8.5"	9.5"	10.5"	13"
9 1/2"	I45L / I45	1'-0"	<b>2'-6"</b>	<b>5'-0"</b>	-	-	-	-	-	-	-
	I58 / I65	1'-6"	<b>4'-0"</b>	<b>6'-6"</b>	-	-	-	-	-	-	-
	I90	3'-0"	5'-6"	<b>8'-0"</b>	-	-	-	-	-	-	-
11 7/8"	I45L / I45	1'-0"	<b>2'-0"</b>	<b>4'-0"</b>	<b>6'-6"</b>	-	-	-	-	-	-
	I58 / I65	1'-0"	3'-0"	<b>5'-6"</b>	<b>8'-6"</b>	-	-	-	-	-	-
	I90 / I90H	2'-0"	4'-6"	7'-6"	<b>10'-0"</b>	-	-	-	-	-	-
	I90HS	3'-6"	6'-0"	9'-0"	-	-	-	-	-	-	-
14"	I45L / I45	1'-0"	1'-0"	3'-0"	<b>5'-0"</b>	<b>7'-6"</b>	-	-	-	-	-
	I58 / I65	1'-0"	1'-6"	4'-0"	<b>7'-0"</b>	<b>10'-6"</b>	-	-	-	-	-
	I90 / I90H	1'-0"	3'-6"	6'-0"	9'-0"	<b>12'-6"</b>	-	-	-	-	-
	I90HS	4'-0"	6'-6"	9'-0"	11'-6"	-	-	-	-	-	-
16"	I45 / I65	1'-0"	1'-0"	2'-0"	<b>4'-0"</b>	<b>6'-6"</b>	<b>10'-0"</b>	-	-	-	-
	I58	1'-0"	1'-0"	2'-0"	<b>4'-0"</b>	<b>6'-6"</b>	<b>10'-0"</b>	-	-	-	-
	I90 / I90H	1'-0"	1'-6"	4'-6"	8'-0"	11'-0"	<b>14'-6"</b>	-	-	-	-
	I90HS	3'-0"	6'-0"	8'-6"	11'-6"	14'-0"	-	-	-	-	-
18"	I45 / I65	1'-0"	1'-0"	1'-0"	2'-6"	<b>5'-0"</b>	<b>8'-0"</b>	<b>12'-0"</b>	-	-	-
	I90 / I90H	1'-0"	1'-0"	2'-6"	5'-6"	9'-0"	12'-6"	<b>17'-0"</b>	-	-	-
	I90HS	2'-6"	5'-6"	8'-0"	11'-0"	13'-6"	16'-6"	-	-	-	-
20"	I45 / I65	1'-0"	1'-0"	1'-0"	3'-6"	<b>6'-0"</b>	<b>9'-0"</b>	<b>13'-6"</b>	-	-	-
	I90 / I90H	1'-0"	1'-0"	1'-0"	3'-6"	7'-0"	10'-6"	14'-6"	<b>19'-6"</b>	-	-
	I90HS	2'-0"	5'-0"	7'-6"	10'-6"	13'-6"	16'-0"	19'-6"	-	-	-
22"	I65	1'-0"	1'-0"	1'-0"	1'-0"	2'-0"	4'-6"	7'-0"	10'-0"	<b>15'-0"</b>	-
	I90 / I90H	1'-0"	1'-0"	1'-6"	4'-0"	6'-6"	9'-6"	12'-0"	16'-0"	-	-
	I90HS	1'-0"	3'-0"	6'-0"	9'-0"	12'-6"	15'-6"	18'-6"	22'-0"	-	-
24" to 26"	I65	1'-0"	1'-0"	1'-6"	3'-0"	4'-6"	6'-0"	7'-6"	10'-0"	<b>13'-6"</b>	-
	I90 / I90H	1'-6"	3'-0"	4'-6"	6'-0"	7'-6"	9'-0"	11'-0"	14'-0"	<b>18'-6"</b>	-
	I90HS	1'-6"	4'-0"	6'-6"	9'-0"	11'-6"	14'-0"	17'-0"	20'-0"	23'-0"	-
28" to 32"	I65	1'-0"	1'-0"	1'-6"	3'-0"	4'-6"	6'-0"	7'-6"	9'-0"	11'-0"	<b>13'-6"</b>
	I90 / I90H	1'-6"	3'-0"	4'-6"	6'-0"	7'-6"	9'-0"	11'-0"	12'-6"	15'-6"	18'-6"
	I90HS	1'-0"	2'-6"	4'-6"	7'-0"	9'-6"	12'-0"	14'-6"	17'-0"	19'-6"	21'-6"

## General Notes

- Tables are based on maximum allowable uniform loads. **Bold Italic** cells indicate 2000 lb. concentrated load spread over two joists has not been considered, use RedSpec™ software or contact your RedBuilt™ technical representative if concentrated load check is required.
- For other hole sizes, hole locations, or loads, use RedSpec™ software or contact your RedBuilt™ technical representative.
- Holes may be located vertically anywhere in the web. Leave 1/8" of web (minimum) at top and bottom of hole. **DO NOT cut joist flanges.**
- Knockouts are located in web at approximately 12" on-center; they do not affect hole placement.
- Do not cut holes in cantilever without consulting your RedBuilt™ representative.**

## How to use Tables A and B

- Determine the hole shape and size. For rectangular holes, use the largest dimension of the rectangle. Sizes given in the table are hole sizes, not duct sizes.
- Determine the Red-I™ joist series and depth.
- Determine the type of support on each side of the hole. If the Red-I™ joist is continuous over a support, use both tables. Use Table A if the joist terminates at both supports.
- Find the table cell at the intersection of the Red-I™ joist and the hole.
- The measurement shown is the minimum distance from the edge of the hole to the inside face of the support.
- Maintain the minimum required distance from both supports.
- It is permissible to interpolate between hole sizes shown in the tables.



Engineered Wood Products

# I-JOIST INSTALLATION INFORMATION

## ATTENTION BUILDER

Enclosed is **IMPORTANT** information on how to safely and properly install RedBuilt™ Joists. Personal injury or death may result from failure to read and follow this information.

## 1 PRODUCT HANDLING

**THIS**

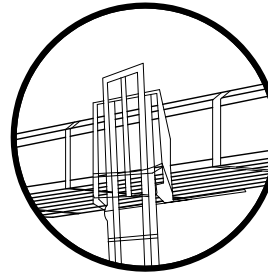

Lift I-joists from underside only. DO NOT dump or drop from truck.

**NOT THIS**



DO NOT lift I-joists by top flange

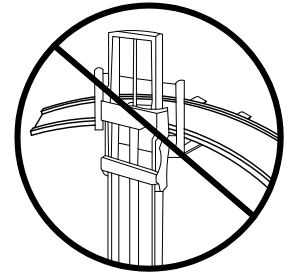

DO NOT lift I-joists in the flat orientation

## 2 PRODUCT STORAGE

**THIS**

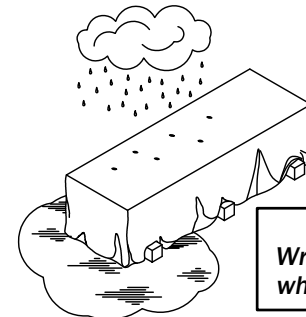

**CAUTION**  
Wrap is slippery when wet or icy.

- Protect products from sun and water.
- Use support blocks at 10' on-center to keep products out of mud and water.

**NOT THIS**

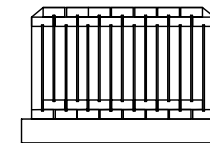

Store and handle joists in vertical orientation. Leave joists banded together until ready to install.

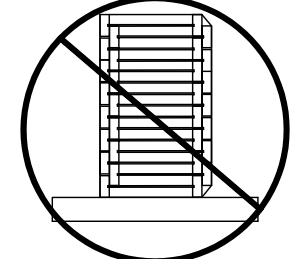

DO NOT store I-joists in the flat orientation

### WARNING

Workers should stay clear when cutting the banding to avoid possible injury from flying banding or toppling joists.

RedBuilt™ Red-I® Product Sections Refer to plan for series and depth

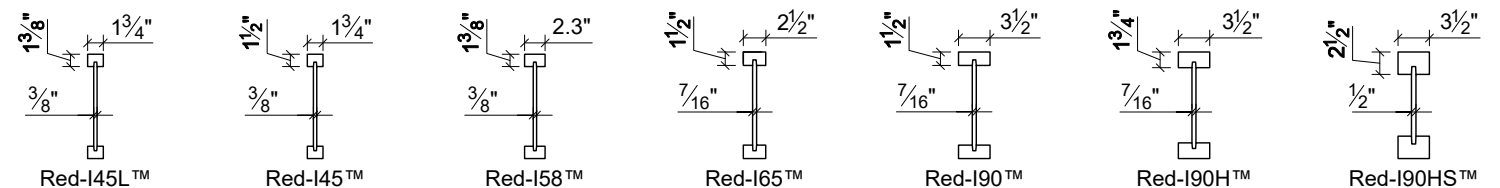

For allowable holes and fasteners information please scan the QR code or use the link below to access page number 3 of sprinkler system installation guide



For product warranty information please scan the QR code or use the link below to access the form

**If you have questions or concerns:**  
 Call your RedBuilt™ Representative directly, or for general customer service call (866) 859-6757

### 3 GENERAL INFORMATION

- All nails specified in framing package to be "common" nails unless noted otherwise. Use proper size nails to fill all nail holes in bearing clips, bridging clips, bracing, etc.
- Do not scale drawings: written dimensions take precedence.
- Manufacturer's responsibility is only for the design of the RedBuilt™ products and not for any supporting structure or loads other than indicated herein. All materials shall be supplied by others, unless specifically noted as "by RB" or "by RedBuilt™" herein.

Abbreviation	Term
AFP	Approved for Production
AOR	Architect of Record
CL	Centerline
DBL	Double
DL	Dead Load
EOR	Engineer of Record
FBO	Framing by Others
FOC	Face of Concrete
FOS	Face of Stud
GC	General Contractor
LL	Live Load
LSL	Laminated Strand Lumber
LVL	Laminated Veneer Lumber
OFA	Out for Approval
OW	Open-Web Trusses by RedBuilt™
PLT	Plate
PSL	Parallel Stranded Lumber
RB	RedBuilt™

### 4 WEB STIFFENER REQUIREMENTS

#### Web Stiffener Size and Material

Flange Width	Web Stiffener Size	Web Stiffener Material
1 3/4"	5/8" x 2 5/16"	Sheathing (with face grain vertical) that meets the requirements of PS1 or PS2
2.3", 2 1/2"	7/8" x 2 5/16"	
3 1/2"	2x4	Construction grade or better Red-I90HS™ Joists require LVL/LSL

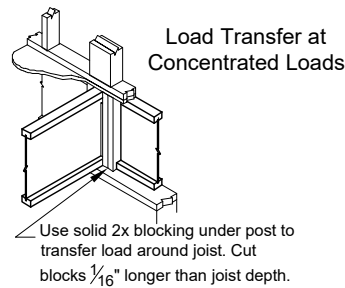

- Web stiffener requirements vary based on joist series and depth; they are always required at bearing on joists 20" in depth or greater.
- See plan/details for requirements specific to the joists being used on this project.
- If web stiffeners are required at hanger locations, they must be attached before placing joist in hanger.

#### Nailing Quantities for Web Stiffener Attachment

I-Joist Depth	Red-I45L™ & Red-I45S™ & Red-I60S™ & Red-I90H™		Red-I90HS™ Joists	
	8dx2 1/2" Nails	8dx2 1/2" Nails	16dx3 1/2" Nails	16dx3 1/2" Nails
	End or Intermediate	End or Intermediate	End	Intermediate
9 1/2"	3	N/A	N/A	N/A
11 7/8"	3	3	3	3
14"	3	5	3	3
16"	3	6	4	4
18"	3	7	4	4
20"	3	8	5	5
22"	N/A	9	6	11
24"	N/A	10	6	13
26"	N/A	11	7	14
28"	N/A	12	8	15
30"	N/A	13	8	17
32"	N/A	N/A	9	18

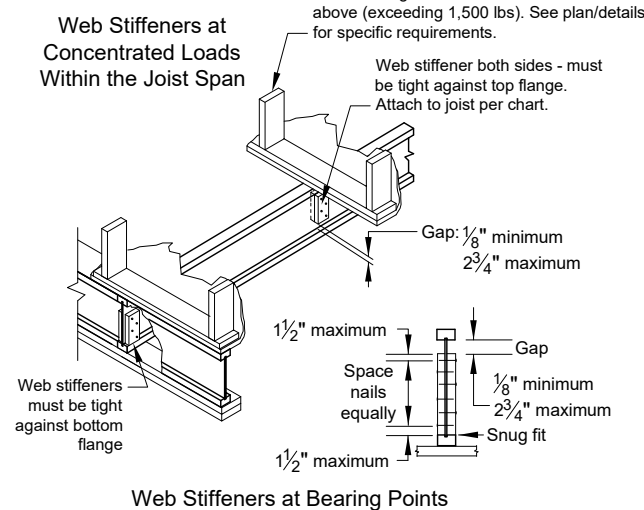

### 5 FLANGE AND BEAM NAILING

Nailing pattern to be per contract drawings and specifications. In addition, nail spacing shall comply with the criteria listed.

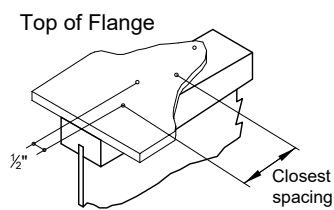

**Joist attachment:** For 1 3/8" thick flanges, attach with a minimum of one 8dx2 1/2" box nail, each side of Red-I™ joist at bearing. Use 10dx3" box nails with 1 1/2" thick flanges, 12dx3 1/4" box nails with 1 3/4" thick flanges and 16dx3 1/2" box nails with 2 1/2" thick flanges. Maintain 1/2" minimum end distance to minimize splitting.

**IMPORTANT**  
Nailing closer than specified may cause the flange to split.

#### Nailing of sheathing

Nail Type	Nail Size	Closest On-Center Spacing Per Row <sup>(1)</sup>		
		1 1/2" Thick I-Joist Flange <sup>(2)</sup>	1 3/8" Thick I-Joist Flange <sup>(2)(6)</sup>	RedLam™ LVL Narrow Face
8dx2 1/2" <sup>(3)</sup>	.113" x 2 1/2"	2"	4"	3"
	.131" x 2 1/2"	2"	4"	3"
10d	.128" x 3"	2"	4"	3"
	.148" x 3"	3"	4"	4" <sup>(4)</sup>
12d	.128" x 3 1/4"	2"	4"	3"
	.148" x 3 1/4"	3"	4"	4" <sup>(4)</sup>
16d	.135" x 3 1/2"	3"	4"	4"
	.148" x 3 1/4"	3"	4"	4" <sup>(4)</sup>
	.162" x 3 1/2"	4"	6"	8" <sup>(5)</sup>

- If more than one row of nails is used, offset rows at least 1/2" and stagger. Maintain 3/8" minimum edge distance.
- Sheathing must be nailed to the full length of the top (or compression) flange on the I-joist with the maximum nail spacing as follows:
  - 18" OC for I-joists with flange widths less than 2".
  - 24" OC for I-joists with flange widths greater than 2".
- 14-gauge staples may be a direct substitute for 8dx2 1/2" nails if a minimum penetration of 1" into the flange is maintained.
- Minimum spacing must be 5" for 4 rows of nails.
- Spacing may be reduced to 5" where nail penetration does not exceed 1 3/8".
- For diaphragm nailing criteria see section 4.2.7 AWC SDPWS-2008. Maximum diaphragm nail penetration for Red-I45L™ and Red-I58™ joists is 1 3/8".

### 6 INSTALLATION BRACING

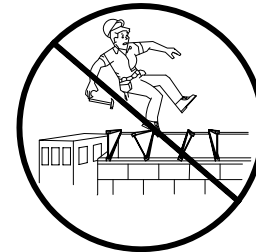

**DO NOT walk on the joists until all joist bearings and bracing have been permanently attached. Injury may result.**

**WARNING**  
Without correctly installed bracing, joists can buckle sideways or roll over, causing death, serious personal injury, or property damage.

**NOTICE**  
Installation bracing and procedures, as well as the safety of workers, are the responsibility of the installer. The installer should make sure that this installation information is understood by all persons involved in the joist installation.

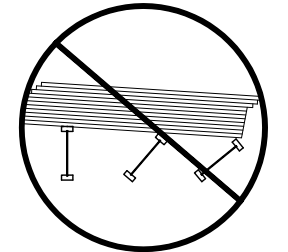

**DO NOT stack building materials on unsheathed joists. Stack only over beams or walls.**

#### IMPORTANT

Strut lines must extend to braced end wall, beam or sheathing.

Strut lines (1x4 minimum)

- 6' on-center for joists with 1 3/4" wide flanges
- 8' on-center for joists with 2.3" & 2 1/2" wide flanges
- 10' on-center for joists with 3 1/2" wide flanges

Strut lines are required at all bearing locations where joists are not otherwise braced.

Cantilever bracing may be required. See plan. Ends of cantilevers must be laterally stabilized with blocking, bracing or rim joist

I-joist blocking panel (or equal) required at each side of I-joist for lateral stability and to transfer wall load above (as occurs) to bearing wall below. See plan/details for specific applications.

Blocking attachment: Minimum 10dx3" nails at 12" OC each side of I-joist blocking panel. When used for shear transfer, nail to bearing plate with connections equivalent to sheathing nail schedule.

4' (minimum) strip of sheathing (temporary or permanent) if there is no braced end wall. If permanent, fasten per plans and specifications. If temporary, use 8dx2 1/2" (0.113"Øx2 1/2") nails at 12" OC.

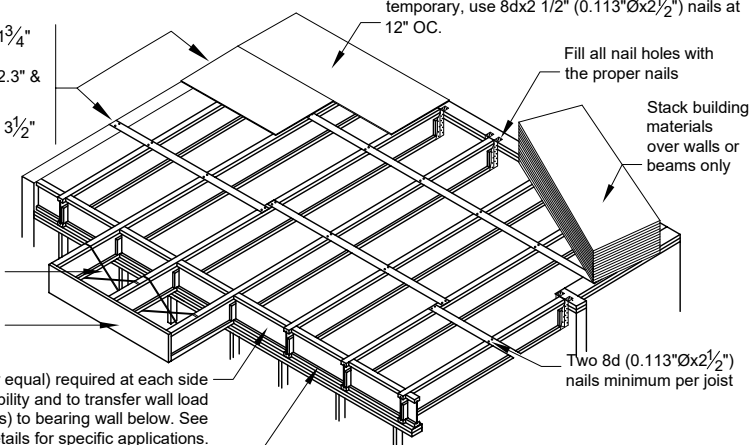

#### WARNING

- All blocking, hangers, rim boards, and rim joists at the end supports of the I-joists must be completely installed and properly nailed.
- I-joist flanges must remain straight within 1/2" from true alignment.
- Sheathing must be completely attached to each I-joist before additional loads can be placed on the system.
- Without bracing, buckling sideways or rollover is highly probable under light construction loads like a worker or stacked sheathing.

### 7 STANDARD INSTALLATION DETAILS

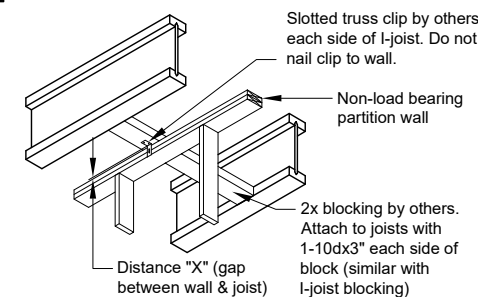

#### Spacing of clips and blocks per EOR

Span	Distance "X"		Span	Distance "X"
	Under Roof	Under Floor		
0'-20'	1 1/4"	3/4"	0'-20'	3/4"
20'-40'	2 1/2"	1 1/4"	20'-40'	1 1/4"
40'-60'	4"	2"	40'-60'	2"

#### Recommended Attachment for Non-load Bearing Partitions

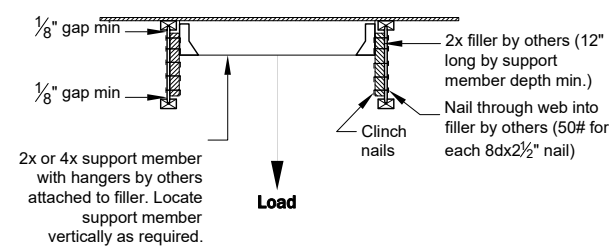
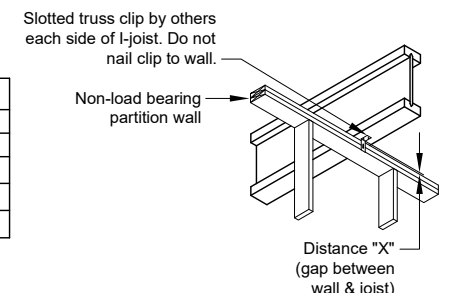

Note: Use this detail for loads exceeding 250 lbs. per I-joist. A 250 lb. load can be supported on each side of the joist's bottom flange at 5'-0" on center, provided the load is included in normal design loads.

#### Support Detail for Loads Supported from I-joist

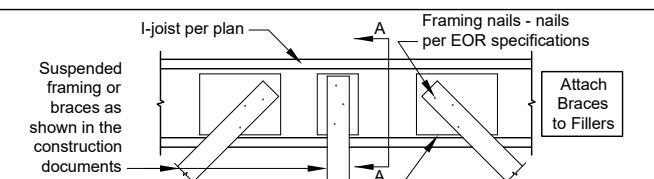

Filler Nailing Chart

Specified Framing Nails	Req'd Filler Nails* (each side)
2-10d (3")	2
4-10d (3")	3
6-10d (3")	5
2-16d (3 1/2")	2
4-16d (3 1/2")	3
6-16d (3 1/2")	5

\* Filler nails shall be 16d sinker or 12d common (0.148"Ø, 3 1/4" long)

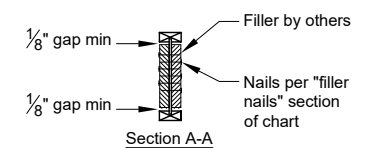

#### Suspended Framing from I-joists