

# 8 ALLOWABLE HOLES

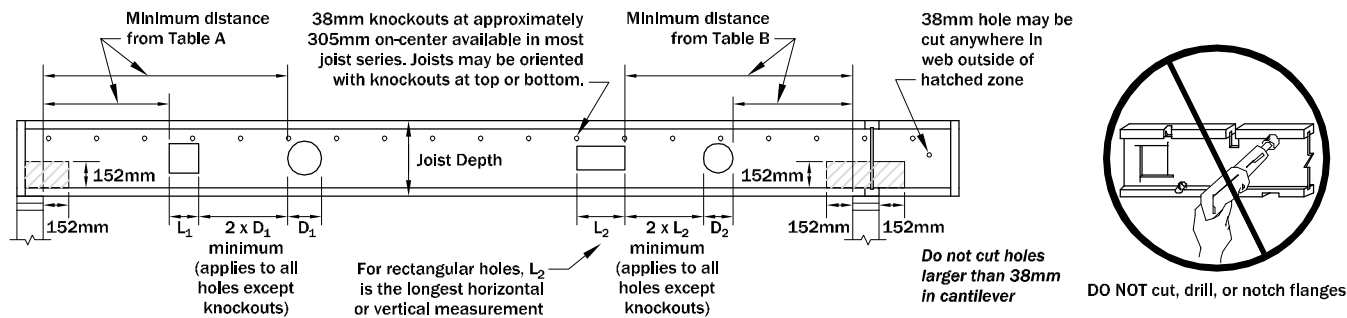

**Table A - End Support**  
Minimum distance (mm) from edge of hole to inside face of nearest end support

Joist Depth (mm)	Joist Series	Round Hole Size (mm)									
		51	102	152	203	254	305	356	406	457	508
		Square or Rectangular Hole Size (mm)									
		32	64	102	127	152	178	216	241	267	330
241	I45 / I65	457	<i>914</i>	<i>1524</i>	-	-	-	-	-	-	-
	I90	610	1067	<i>1676</i>	-	-	-	-	-	-	-
302	I45 / I65	457	762	<i>1219</i>	<i>1676</i>	-	-	-	-	-	-
	I90 / I90H	457	1067	1676	<i>2134</i>	-	-	-	-	-	-
	I90HS	610	1219	1981	-	-	-	-	-	-	-
356	I45 / I65	305	610	1067	<i>1372</i>	<i>1981</i>	-	-	-	-	-
	I90 / I90H	305	914	1524	1981	<i>2743</i>	-	-	-	-	-
	I90HS	610	1219	1829	2438	-	-	-	-	-	-
406	I45 / I65	305	457	914	1219	<i>1524</i>	<i>2438</i>	-	-	-	-
	I90 / I90H	305	610	1219	1829	2591	<i>3200</i>	-	-	-	-
	I90HS	610	1219	1829	2438	3048	-	-	-	-	-
457	I45 / I65	305	305	762	1067	1372	<i>1829</i>	<i>2743</i>	-	-	-
	I90 / I90H	305	305	762	1524	2134	2896	<i>3810</i>	-	-	-
	I90HS	610	1219	1829	2438	3048	3658	-	-	-	-
508	I45 / I65	305	305	610	914	1219	1524	<i>2134</i>	<i>3200</i>	-	-
	I90 / I90H	305	305	610	1219	1829	2438	3353	<i>4267</i>	-	-
	I90HS	610	1219	1829	2438	2896	3505	4267	-	-	-
559	I65	305	305	457	762	1067	1372	1676	2286	<i>3505</i>	-
	I90 / I90H	305	305	305	914	1524	2134	2743	3810	<i>4877</i>	-
	I90HS	610	1219	1829	2438	2896	3505	4115	4877	-	-
610 to 660	I65	305	457	762	1067	1219	1524	1829	2286	<i>3048</i>	-
	I90 / I90H	305	305	610	1067	1524	1981	2591	3200	4420	<i>5639</i>
	I90HS	610	1219	1829	2286	2896	3505	4115	4572	5486	-
711 to 813	I65	305	610	762	1067	1219	1524	1829	2134	2438	3200
	I90 / I90H	305	457	762	1219	1676	1981	2438	2896	3505	4420
	I90HS	610	1067	1524	2134	2591	3048	3658	4115	4877	5639

**Table B - Intermediate or Cantilever Support**  
Minimum distance (mm) from edge of hole to inside face of nearest intermediate or cantilever support

Joist Depth (mm)	Joist Series	Round Hole Size (mm)									
		51	102	152	203	254	305	356	406	457	508
		Square or Rectangular Hole Size (mm)									
		32	64	102	127	152	178	216	241	267	330
241	I45 / I65	457	<i>1219</i>	<i>1981</i>	-	-	-	-	-	-	-
	I90	914	1676	<i>2438</i>	-	-	-	-	-	-	-
302	I45 / I65	305	610	<i>1372</i>	<i>2134</i>	-	-	-	-	-	-
	I90 / I90H	610	1372	2286	<i>3048</i>	-	-	-	-	-	-
	I90HS	1067	1829	2743	-	-	-	-	-	-	-
356	I45 / I65	305	305	1067	<i>1676</i>	<i>2591</i>	-	-	-	-	-
	I90 / I90H	305	1067	1829	2743	<i>3810</i>	-	-	-	-	-
	I90HS	1219	1981	2743	3505	-	-	-	-	-	-
406	I45 / I65	305	305	610	<i>1219</i>	<i>1981</i>	<i>3048</i>	-	-	-	-
	I90 / I90H	305	457	1372	2438	3353	<i>4420</i>	-	-	-	-
	I90HS	914	1829	2591	3505	4267	-	-	-	-	-
457	I45 / I65	305	305	305	762	<i>1524</i>	<i>2438</i>	<i>3658</i>	-	-	-
	I90 / I90H	305	305	762	1676	2743	3810	<i>5182</i>	-	-	-
	I90HS	762	1676	2438	3353	4115	5029	-	-	-	-
508	I45 / I65	305	305	305	305	1067	<i>1829</i>	<i>2743</i>	<i>4115</i>	-	-
	I90 / I90H	305	305	305	1067	2134	3200	4420	<i>5944</i>	-	-
	I90HS	610	1524	2286	3200	4115	4877	5944	-	-	-
559	I65	305	305	305	305	610	1372	2134	3048	<i>4572</i>	-
	I90 / I90H	305	305	457	1219	1981	2896	3658	4877	-	-
	I90HS	305	914	1829	2743	3810	4724	5639	6706	-	-
610 to 660	I65	305	305	457	914	1372	1829	2286	3048	<i>4115</i>	-
	I90 / I90H	457	914	1372	1829	2286	2743	3353	4267	<i>5639</i>	-
	I90HS	457	1219	1981	2743	3505	4267	5182	6096	7010	-
711 to 813	I65	305	305	457	914	1372	1829	2286	2743	3353	<i>4115</i>
	I90 / I90H	457	914	1372	1829	2286	2743	3353	3810	4724	5639
	I90HS	305	762	1372	2134	2896	3658	4420	5182	5944	6553

## General Notes

- Tables are based on maximum allowable uniform loads. ***Bold Italic*** cells indicate 8.9 kN concentrated load spread over two joists has not been considered, use RedSpec™ software or contact your RedBuilt™ technical representative if concentrated load check is required.
- For other hole sizes, hole locations, or loads, use RedSpec™ software or contact your RedBuilt™ technical representative
- Holes may be located vertically anywhere in the web. Leave 3mm of web (minimum) at top and bottom of hole. **DO NOT** cut joist flanges.
- Knockouts are located in web at approximately 305mm on-center; they do not affect hole placement.
- Do not cut holes in cantilever without consulting your RedBuilt™ representative.

## How to use Tables A and B

1. Determine the hole shape and size. For rectangular holes, use the largest dimension of the rectangle. Sizes given in the table are hole sizes, not duct sizes.
2. Determine the Red-Built™ joist series and depth.
3. Determine the type of support on each side of the hole. If the Red-Built™ Joist is continuous over a support, use both tables. Use Table A if the joist terminates at both supports.
4. Find the table cell at the intersection of the Red-Built™ joist and the hole.
5. The measurement shown is the minimum distance from the edge of the hole to the inside face of the support.
6. Maintain the minimum required distance from both supports.
7. It is permissible to interpolate between hole sizes shown in the tables.



# I-JOIST INSTALLATION INFORMATION

**ATTENTION BUILDER**  
Enclosed is **IMPORTANT** information on how to safely and properly install RedBuilt™ Joists. Personal injury or death may result from failure to read and follow this information.

## 1 PRODUCT HANDLING

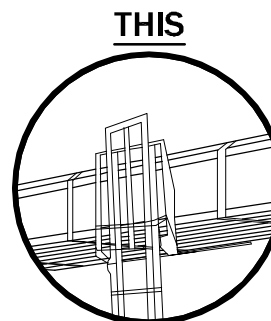

**THIS**  
Lift I-joists from underside only. DO NOT dump or drop from truck.

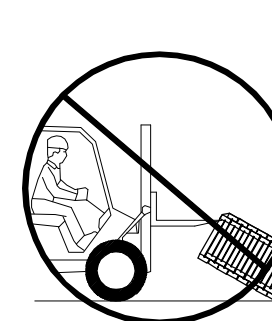

**NOT THIS**  
DO NOT lift I-joists by top flange

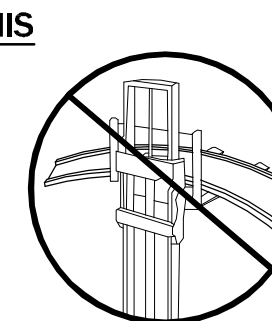

**NOT THIS**  
DO NOT lift I-joists in the flat orientation

## 2 PRODUCT STORAGE

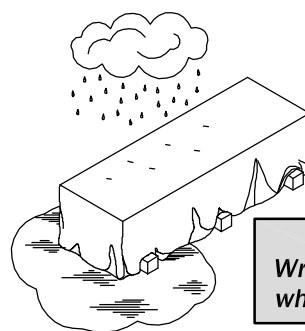

**THIS**  
**CAUTION**  
Wrap is slippery when wet or icy.

- Protect products from sun and water.
- Use support blocks at 3048mm on-center to keep products out of mud and water.

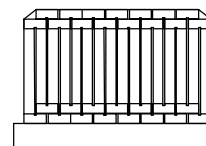

**NOT THIS**  
Store and handle joists in vertical orientation. Leave joists banded together until ready to install.

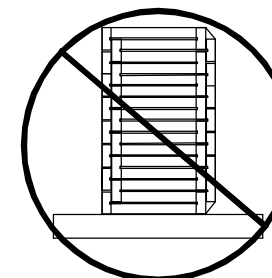

**DO NOT** store I-joists in the flat orientation

**WARNING**  
Workers should stay clear when cutting the banding to avoid possible injury from flying banding or toppling joists.

RedBuilt™ Red-I® Product Sections Refer to plan for series and depth

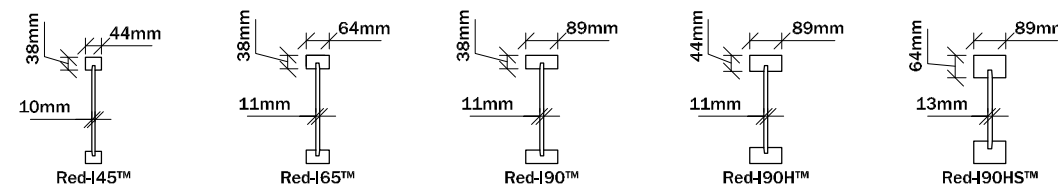

**If you have questions or concerns:**  
Call your RedBuilt™ Representative directly,  
or for general customer service call  
(866) 859-6757

### 3 GENERAL INFORMATION

- All nails specified in framing package to be "common" nails unless noted otherwise. Use proper size nails to fill all nail holes in bearing clips, bridging clips, bracing, etc.
- Do not scale drawings: written dimensions take precedence.
- Manufacturer's responsibility is only for the design of the RedBuilt™ products and not for any supporting structure or loads other than indicated herein. All materials shall be supplied by others, unless specifically noted as "by RB" or "by RedBuilt™" herein.

Abbreviation	Term
AFP	Approved for Production
AOR	Architect of Record
CL	Centerline
DBL	Double
DL	Dead Load
EOR	Engineer of Record
FBO	Framing by Others
FOC	Face of Concrete
FOS	Face of Stud
GC	General Contractor
LL	Live Load
LSL	Laminated Strand Lumber
LVL	Laminated Veneer Lumber
OFA	Out for Approval
OW	Open-Web Trusses by RedBuilt™
PLT	Plate
PSL	Parallel Stranded Lumber
RB	RedBuilt™

### 4 WEB STIFFENER REQUIREMENTS

#### Web Stiffener Size and Material

Flange Width	Web Stiffener Size	Web Stiffener Material
44mm	16mmx59mm	Sheathing (with face grain vertical) that meets the requirements of PS1 or PS2
64mm	25mmx59mm	
89mm	38x89	Construction grade or better Red-I90HS™ Joists require LVL/LSL

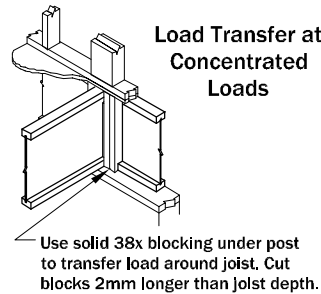

- Web stiffener requirements vary based on joist series and depth; they are always required at bearing on joists 508mm in depth or greater.
- See plan/details for requirements specific to the joists being used on this project.
- If web stiffeners are required at hanger locations, they must be attached before placing joist in hanger.

#### Nailing Quantities for Web Stiffener Attachment

I-Joist Depth	Red-I45™ Joists	Red-I65™ Joists	Red-I90™ & Red-I90H™ Joists		Red-I90HS™ Joists
	8d (64mm) Nails	8d (64mm) Nails	16d (89mm) Nails	16d (89mm) Nails	16d (89mm) Nails
	End or Intermediate	End or Intermediate	End	Intermediate	End or Intermediate
241mm	3	N/A	N/A	N/A	N/A
302mm	3	3	3	3	4
356mm	3	5	3	3	6
406mm	3	6	4	4	6
457mm	3	7	4	4	8
508mm	3	8	5	5	10
559mm	N/A	9	6	11	10
610mm	N/A	10	6	13	12
660mm	N/A	11	7	14	14
711mm	N/A	12	8	15	14
762mm	N/A	13	8	17	16
813mm	N/A	N/A	9	18	18

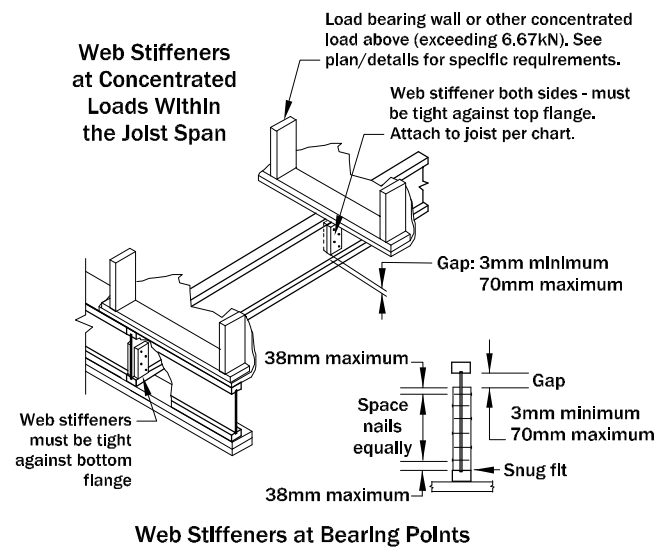

### 5 FLANGE AND BEAM NAILING

Nailing pattern to be per contract drawings and specifications. In addition, nail spacing shall comply with the criteria listed.

**IMPORTANT**  
Nailing closer than specified may cause the flange to split.

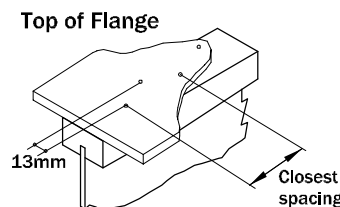

#### Nailing of sheathing

Nail Type	Nail Size	Closest On-Center Spacing Per Row <sup>(1)</sup>	
		I-Joist Flange <sup>(2)</sup>	RedLam™ LVL Narrow Face
8d <sup>(3)</sup>	2.87mm x 64mm	51mm	76mm
	3.33mm x 64mm	51mm	76mm
10d	3.25mm x 76mm	51mm	76mm
	3.76mm x 76mm	76mm	102mm <sup>(4)</sup>
12d	3.25mm x 83mm	51mm	76mm
	3.76mm x 83mm	76mm	102mm <sup>(4)</sup>
16d	3.43mm x 89mm	76mm	102mm
	3.76mm x 83mm	76mm	102mm <sup>(4)</sup>
	4.11mm x 89mm	102mm	203mm <sup>(5)</sup>

- If more than one row of nails is used, offset rows at least 13mm and stagger. Maintain 10mm minimum edge distance.
- Sheathing must be nailed to the full length of the top (or compression) flange on the I-joist with the maximum nail spacing as follows:
  - 457mm OC for I-joists with flange widths less than 51mm.
  - 610mm OC for I-joists with flange widths greater than 51mm.
- 14-gauge staples may be a direct substitute for 8d (64mm) nails if a minimum penetration of 25mm into the flange is maintained.
- Minimum spacing must be 127mm for 4 rows of nails.
- Spacing may be reduced to 127mm where nail penetration does not exceed 35mm.

### 6 INSTALLATION BRACING

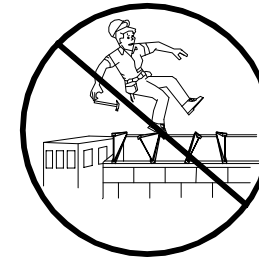

DO NOT walk on the joists until all joist bearings and bracing have been permanently attached. Injury may result.

**WARNING**  
Without correctly installed bracing, joists can buckle sideways or roll over, causing death, serious personal injury, or property damage.

**NOTICE**  
Installation bracing and procedures, as well as the safety of workers, are the responsibility of the installer. The installer should make sure that this installation information is understood by all persons involved in the joist installation.

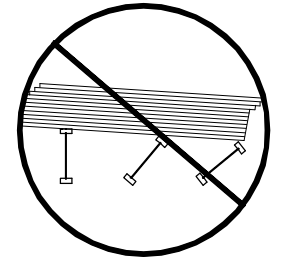

DO NOT stack building materials on unsheathed joists. Stack only over beams or walls.

#### IMPORTANT

Strut lines must extend to braced end wall, beam or sheathing.

- Strut lines (19x89 minimum)
- 1829mm on-center for joists with 44mm wide flanges
- 2438mm on-center for joists with 64mm wide flanges
- 3048mm on-center for joists with 89mm wide flanges

Strut lines are required at all bearing locations where joists are not otherwise braced.

Cantilever bracing may be required. See plan.

Ends of cantilevers must be laterally stabilized with blocking, bracing or rim joist

I-joist blocking panel (or equal) required at each side of I-joist for lateral stability and to transfer wall load above (as occurs) to bearing wall below. See plan/details for specific applications.

Minimum blocking attachment: 10d (76mm) nails at 305mm OC each side of I-joist blocking panel. When used for shear transfer, nail to bearing plate with connections equivalent to sheathing nail schedule.

1219mm (minimum) strip of sheathing (temporary or permanent) if there is no braced end wall. If permanent, fasten per plans and specifications. If temporary, use 8d (2.87mmx64mm) nails at 305mm OC.

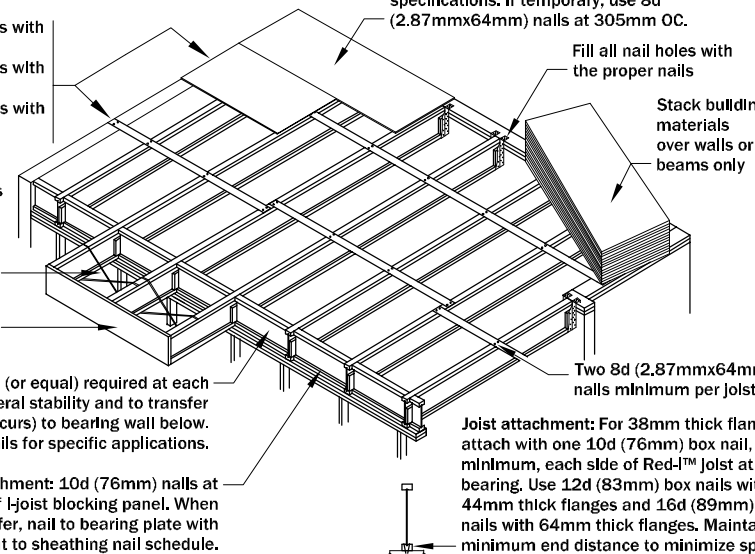

- WARNING**
- All blocking, hangers, rim boards, and rim joists at the end supports of the I-joists must be completely installed and properly nailed.
  - I-joist flanges must remain straight within 13mm from true alignment.
  - Sheathing must be completely attached to each I-joist before additional loads can be placed on the system.
  - Without bracing, buckling sideways or rollover is highly probable under light construction loads like a worker or stacked sheathing.

### 7 STANDARD INSTALLATION DETAILS

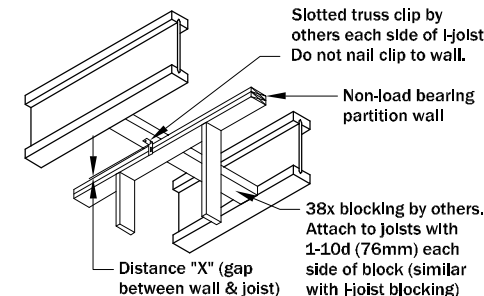

#### Spacing of clips and blocks per EOR

Span	Distance "X"	
	Under Roof "X"	Under Floor "X"
0mm-6096mm	32mm	19mm
6096mm-12192mm	64mm	32mm
12192mm-18288mm	102mm	51mm

#### Recommended Attachment for Non-load Bearing Partitions

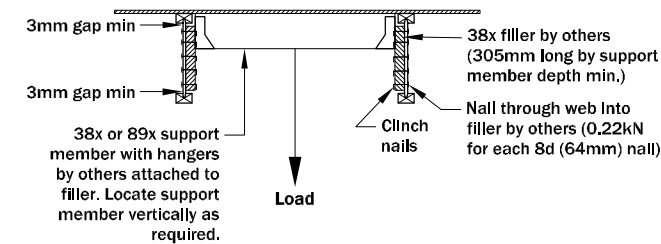
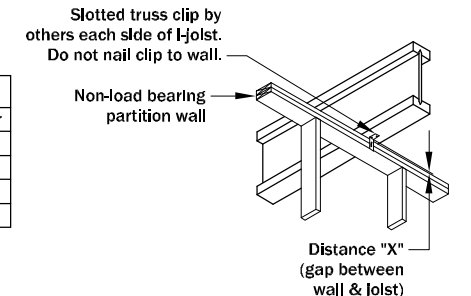

Note: Use this detail for loads exceeding 1.11 kN per I-joist. A 1.11 kN load can be supported on each side of the joist's bottom flange at 1524mm on center, provided the load is included in normal design loads.

#### Support Detail for Loads Supported from I-joist

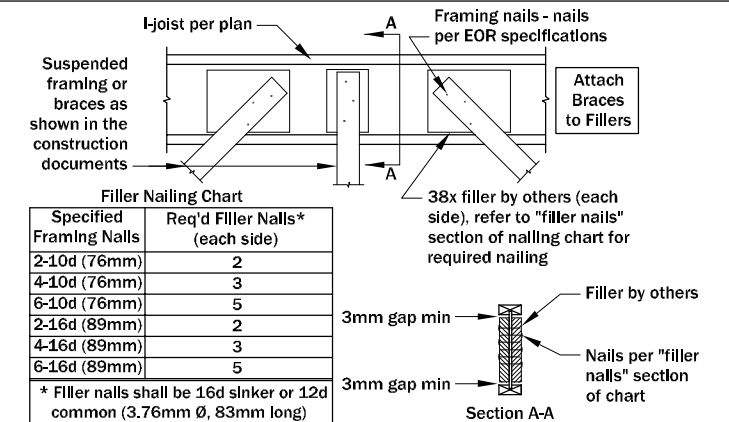

Filler Nailing Chart

Specified Framing Nails	Req'd Filler Nails* (each side)
2-10d (76mm)	2
4-10d (76mm)	3
6-10d (76mm)	5
2-16d (89mm)	2
4-16d (89mm)	3
6-16d (89mm)	5

\* Filler nails shall be 16d slinker or 12d common (3.76mm Ø, 83mm long)